

## GV-ADR2702 2MP H.265 Low Lux WDR IR Mini Fixed Rugged IP Dome



- 1/2.7" progressive scan low lux CMOS sensor
- Min. illumination at 0.02 lux
- Triple streams from H.265, H.264 or MJPEG
- Up to 30 fps at 1920 x 1080
- Intelligent IR
- IR distance up to 30 m (100 ft)
- Day and night function (with removable IR-cut filter)
- Ingress protection (IP67)
- Vandal Resistance (IK10)
- DC 12V / PoE (IEEE 802.3af)
- Wide Dynamic Range (WDR)
- Defog
- 3D noise reduction
- Motion detection
- Text overlay
- Privacy mask
- ONVIF (Profile S, Profile T) conformant

### Introduction

The Mini Fixed Rugged IP Dome is an outdoor, fixed, network camera equipped with an automatic IR-cut filter and an IR LED for day and night surveillance. The camera supports H.265 video codec to achieve better compression ratio while maintaining high quality pictures at reduced network bandwidths. The camera adheres to IP67 and IK10 standards, and can be powered through PoE.

### Models

Model	Iris	Focal Length (mm)	Horizontal FOV	Maximum Aperture	Image Format
GV-ADR2702-0F	Fixed	2.8 mm	110°	F/2.0	1/2.7"
GV-ADR2702-1F		4 mm	83°		

### Dimensions

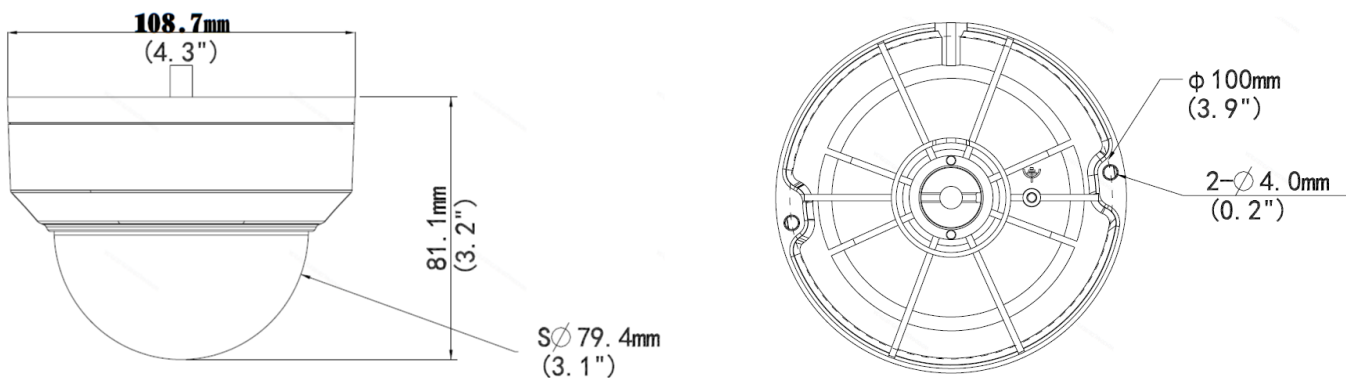

## Specifications

Camera		
Image Sensor	1/2.7" progressive scan low lux CMOS	
Picture Elements	1920 (H) x 1080 (V)	
Minimum Illumination	Color	0.02 Lux (F2.0, AGC ON)
	IR ON	0 Lux
Shutter Speed	Auto / Manual (1/6 ~ 1/100000 sec)	
White Balance	Auto / Manual	
Gain Control	Auto / Manual	
S/N Ratio	52 dB	
WDR	Yes	
Dynamic Range	Up to 72 dB	
Lens		
	<b>GV-ADR2702-0F</b>	<b>GV-ADR2702-1F</b>
Megapixel	2 MP	
Day / Night	Yes (with removable IR-cut filter)	
Lens Type	Fixed	
Focal Length	2.8 mm	4 mm
Maximum Aperture	F/2.0	
Mount	M12	
Horizontal FOV	110°	83°
Operation	Focus	Fixed
	Zoom	Fixed
	Iris	Fixed
IR LED Quantity	1 IR LED	
Max. IR Distance	30 m (100 ft)	
Operation		
Video Compression	H.265, H.264, MJPEG	
Video Streaming	Triple streams from H.265, H.264 or MJPEG	
Video Resolution	Main Stream	1920 x 1080 (Default), 1280 x 720
	Sub Stream	1280 x 720, 720 x 576, 704 x 288, 640 x 360 (Default), 352 x 288
	Third Stream (Closed by Default)	720 x 576, 704 x 288, 640 x 360, 352 x 288
Frame Rate	30 fps at 1920 x 1080 (60 / 50 Hz) * The frame rate and performance may vary depending on the number of connections and data bitrates (different scenes).	
Video Analytics	Motion Detection, Tampering Alarm	
Image Setting	Brightness, Contrast, Saturation, Sharpness, Flicker-less, Image Orientation (Flip, Mirror, 0°, 180°)	
Network		
Interface	10/100 Ethernet	
Protocol	ARP, DHCP, DDNS, DNS, DynDNS, FTP, HTTP, HTTPS, ICMP, IGMP, IPv4, NTP, QoS, RTCP, RTP, RTSP, SMTP, TCP, UDP, UPnP, ONVIF (Profile S, T)	
Mechanical		
Temperature Detector	No	
Camera Angle Adjustment	Pan	0° ~ 360°
	Tilt	0° ~ 75°
Connectors	Power	DC Jack (DC 12 V, 1.25 A), PoE
	Ethernet	RJ-45 connector
General		
Operating Temperature	-30°C ~ 60°C (-22°F ~ 140°F)	
Humidity	10% ~ 90% (no condensation)	
Power Source	12 V DC / PoE (IEEE802.3af)	
Max. Power Consumption	4.5 W	
Dimensions	Ø 108.7 x 81.1 mm (Ø 4.3" x 3.2")	
Weight	0.37 kg (0.81 lb)	
Ingress Protection	IP67	
Vandal Resistance	IK10	

Regulatory	FCC, CE, RoHS compliant
<b>Web Interface</b>	
Installation Management	Web-based configuration
Maintenance	Firmware upgrade through Web Browser or GV-IP Device Utility (V8.7.2.1)
Access from Web Browser	Live View, Video Recording, Change Video Quality, Bandwidth Control, Image Snapshot, Defog, Text Overlay, Image Masking
Language	Czech, English, French, German, Italian, Russian, Traditional Chinese
<b>Applications</b>	
Software Supported	GV-DVR / NVR (V8.8.0), GV-VMS (V17.1.0.100), GV-Control Center (V3.5.1), GV-Edge Recording Manager Windows version (V1.4.0.0), GV-Recording Server / Video Gateway (V1.4.2), GV-Redundant / Failover Server (V1.1.0.0)
Smart Device Access	GV-Eye for iOS and Android
Live Viewing	Browser (IE, Firefox, Safari), Mobile App







**Note:**



1. It is required to apply patch files to some of the supported software.
2. Do not use clothes or any ordinary material to clean the camera cover since they may result in scratches.
3. Specifications are subject to change without notice.

**Packing List**

- |  |                          |
|--|--------------------------|
| 1. GV-ADR2702 IR Mini Fixed Rugged IP Dome | 4. Drill Template Paster |
| 2. Waterproof Rubber Set                   | 5. Download Guide        |
| 3. Screw Kit                               | 6. Warranty Card         |

**Accessories**

Model No.	Name		Details
GV-Mount107 (must be used with GV-Mount213)	Pendant Bracket		Dimensions: $\varnothing$ 120 x 334 mm ( $\varnothing$ 4.72" x 13.15") Weight: 0.74 kg (1.63 lb)
GV-Mount211P	Wall Mount and Junction Box		Dimensions: $\varnothing$ 233 x 125 x 125 mm ( $\varnothing$ 9.2" x 4.9" x 4.9") Weight: 1 kg (2.2 lb)
GV-Mount213	Wall / Ceiling Box Mount		Dimensions: $\varnothing$ 109 x 39 mm ( $\varnothing$ 4.3" x 1.5") Weight: 0.2 kg (0.44 lb)
GV-Mount300-2	Convex Corner Mount		Dimensions: 137 x 233 x 160 mm (5.4" x 9.17" x 6.3") Weight: 1.65 kg (3.64 lb)
GV-Mount310-2	Concave Corner Mount		Dimensions: 111.2 x 369.9 x 210 mm (2.6" x 11.4" x 6.6") Weight: 1.65 kg (3.64 lb)
GV-Mount420 (must be used with GV-Mount211P)	Pole Mount Bracket		Dimensions: $\varnothing$ 120 x 120 x 53.4 mm ( $\varnothing$ 4.7" x 4.7" x 2.1") Weight: 0.45 kg (0.99 lb) Steel Strap Diameter: $\varnothing$ 67 ~ 127 mm ( $\varnothing$ 2.6" ~ 5")

Model No.	Name		Details
GV-Mount704 (must be used with GV-Mount107)	Extension Tube		<p>Dimensions: Ø 3.5 x 10 or 20 or 30 or 50 cm (Ø 1.38 x 3.9 or 7.9 or 11.8 or 19.7")</p> <p>Weight: 225g or 360g or 500g or 780g (0.5 lb or 0.79 lb or 1.1 lb or 1.72 lb)</p>
GV-PA191	Power over Ethernet (PoE) Adapter		<p>The GV-PA191 is a Power over Ethernet (PoE) adapter designed to provide power to the IP device through a single Ethernet cable.</p>
GV-POE Switch	<p>The GV-POE Switch is designed to provide power along with network connection for IP devices. The GV-POE Switch is available in various models with different numbers and types of ports.</p>		
Power Adapter	<p>Contact our sales representatives for the countries and areas supported.</p>		